

Frequency Coordination
Used by
High Frequency Trading Firms
as a
Business Strategy - Spectrum Blocking

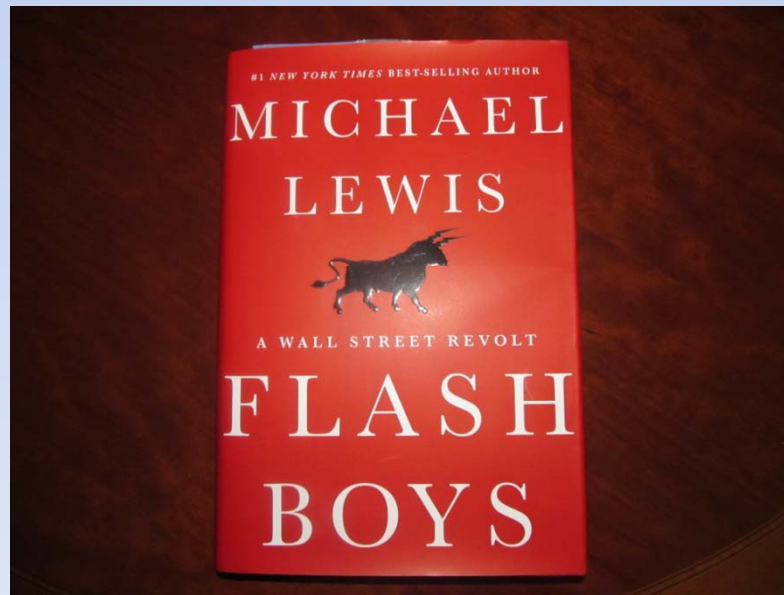

Presented

by

James C. Wolfson

President of X-DOT, Inc.

NSMA

2014

Conference



11 GHz Paths

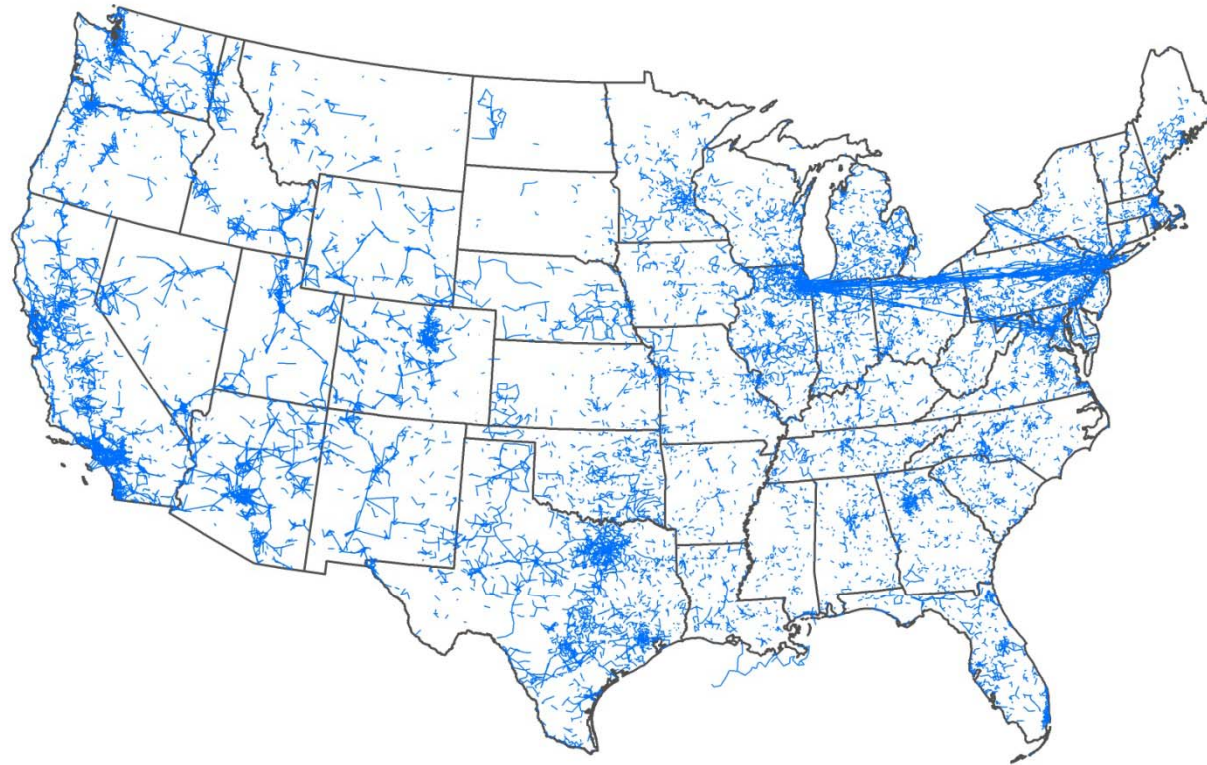

Courtesy Comsearch

Lower 6 GHz Paths

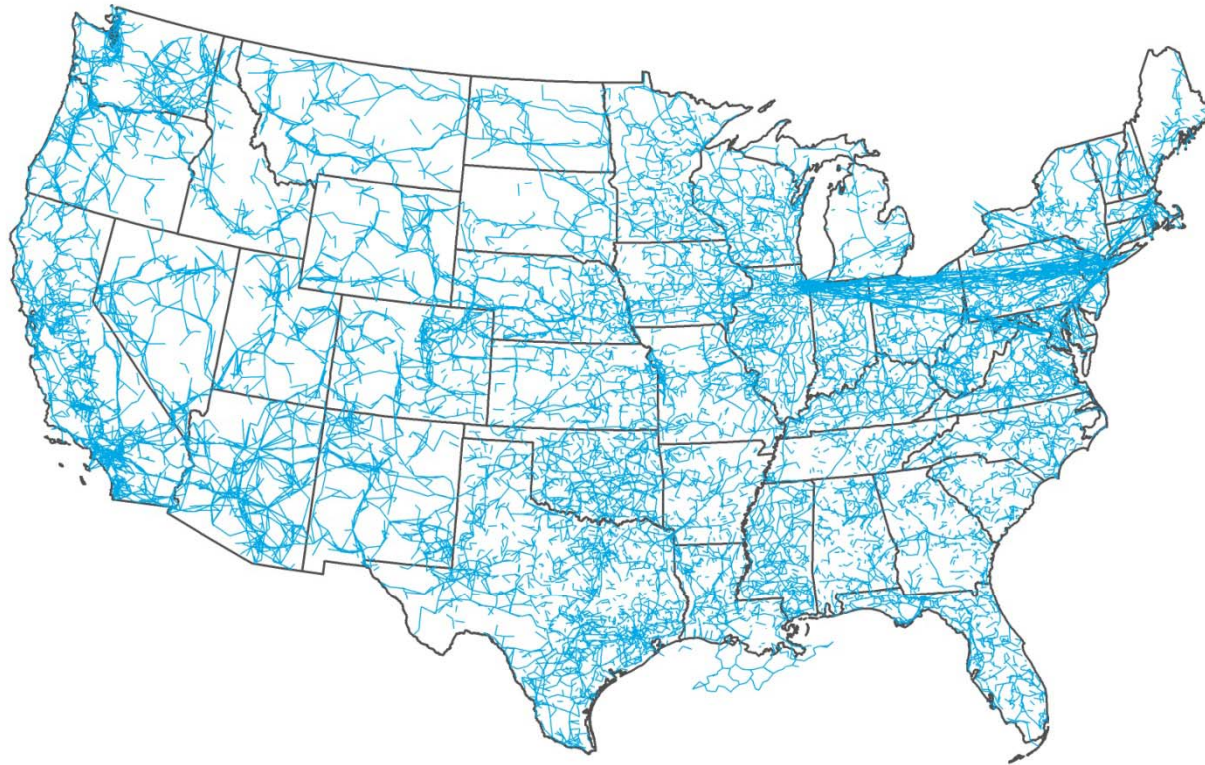

Courtesy Comsearch



X-DOT, Inc.

Upper 6 GHz Paths

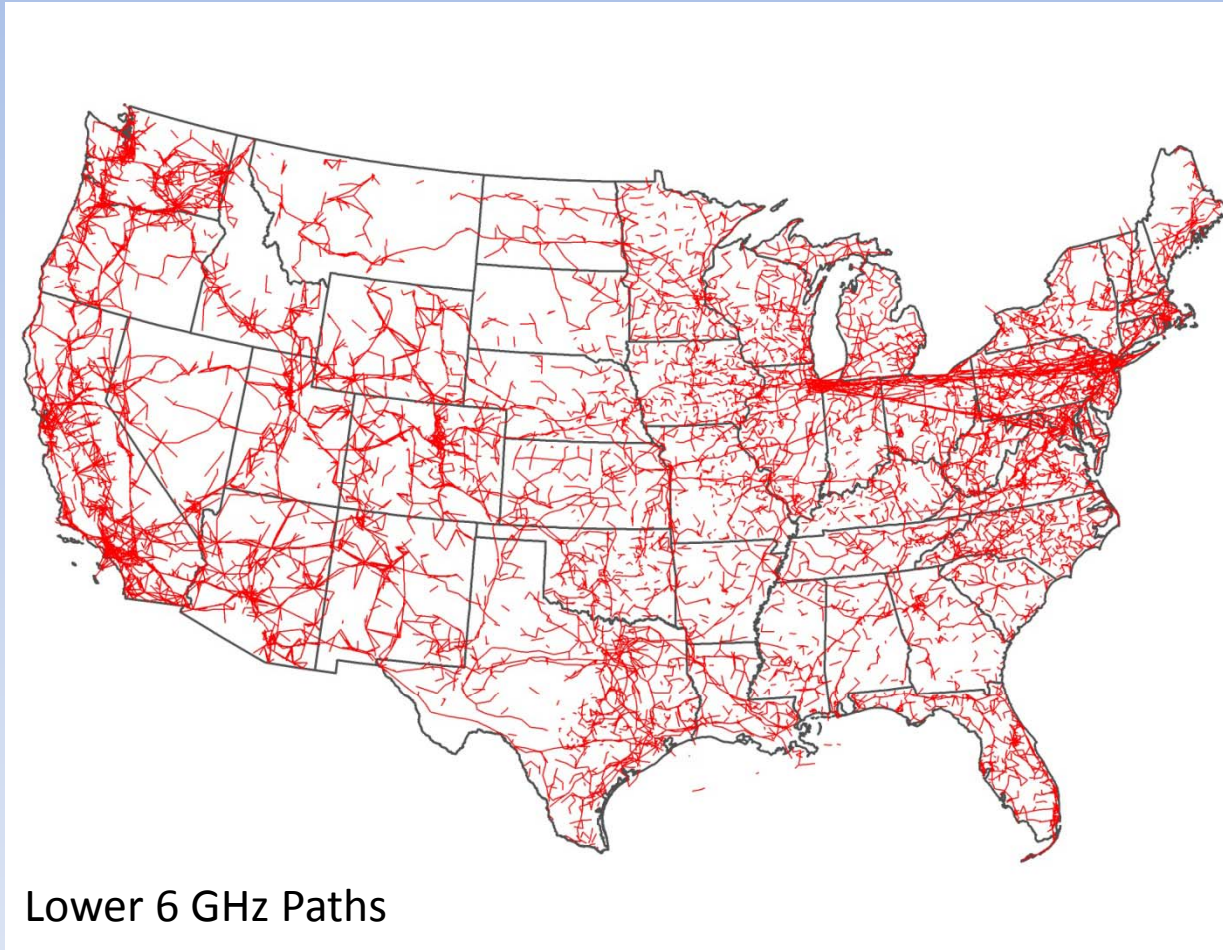

Approx Number of
MW Antennas

250-280	16
200-250	15
140-200	19
30-140	19 2 Exist
30-140	9 4 Exist

Total 65 antennas

Filings happen frequently on this tower as it is 1400' to NASDAQ. Drawing is not current.

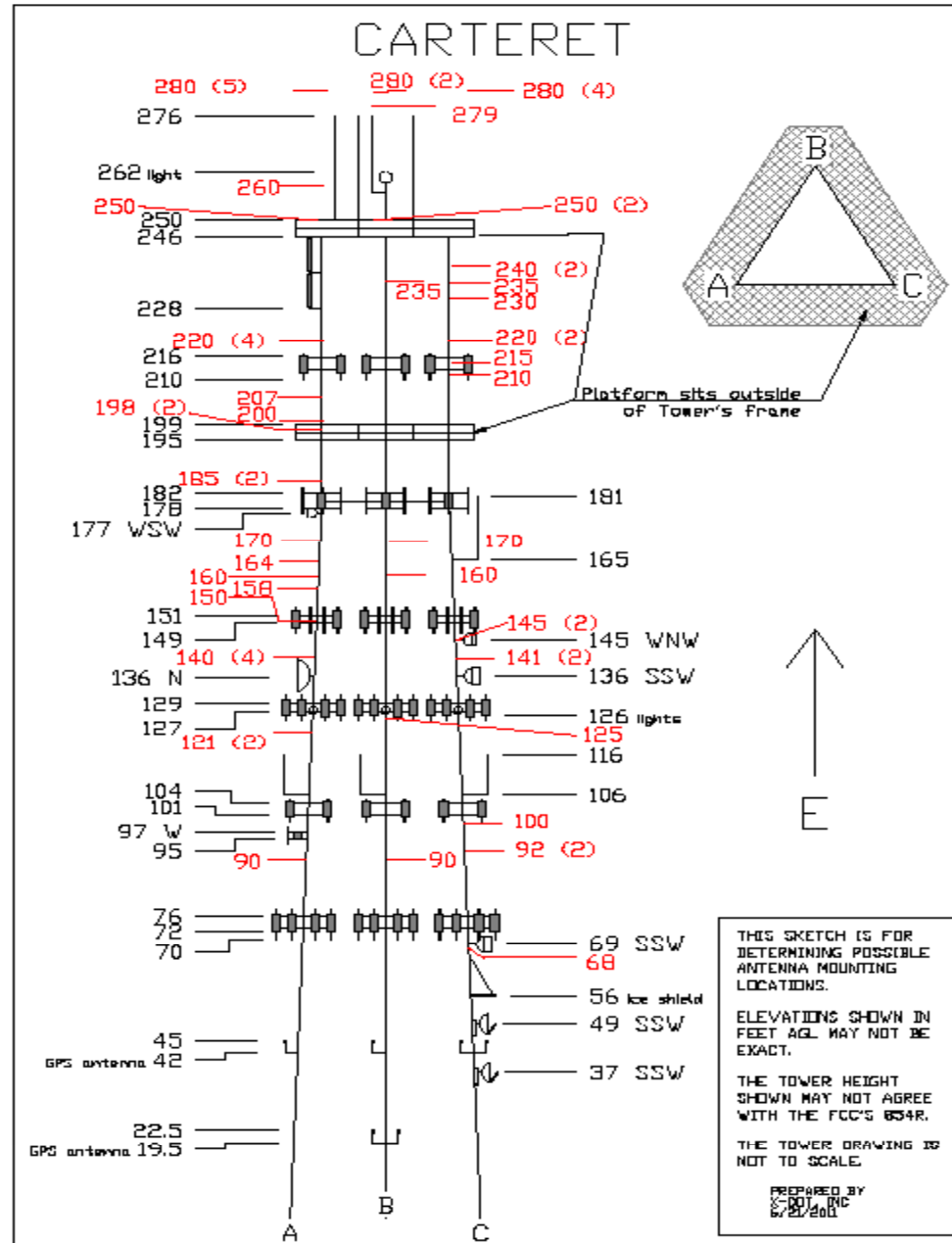

Approx Number of MW Antennas

Top 15

170-195 20 3 Exist

140-170 13

75-140 17 2 Exist

25-75 5

Total 75 antennas

Filings happen frequently on this tower.

Drawing is not current.

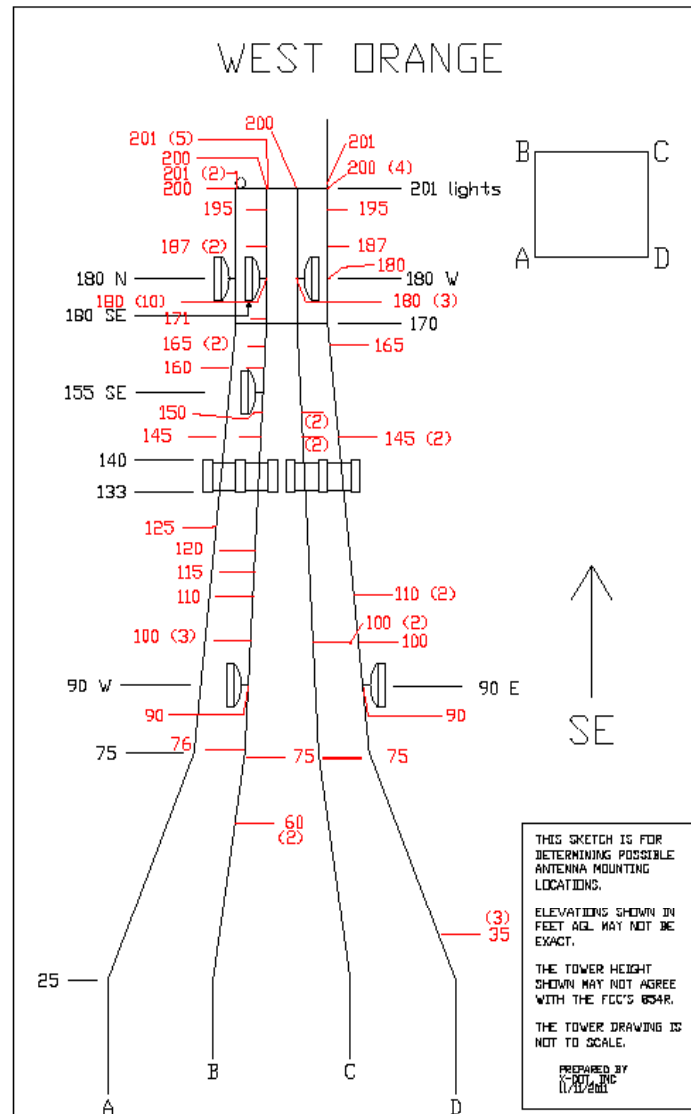

Aurorarents to Alsip and Dolton-interference?

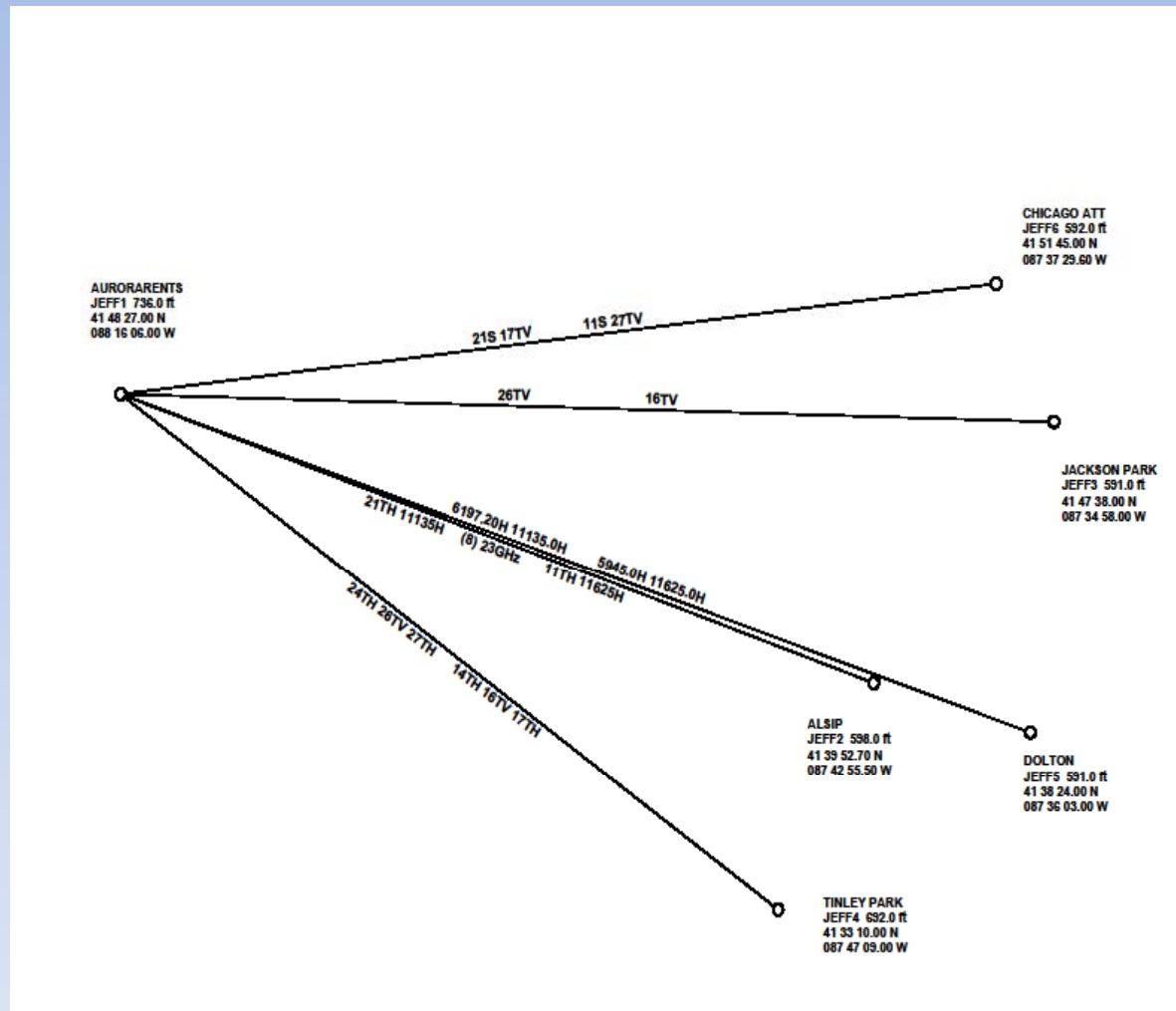

Statistics

- Chicago to NY
 - 109 license applications
 - 131 Licensed
 - 1200 Proposed
 - Most from same company

